

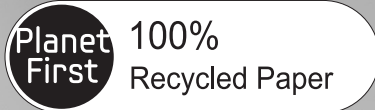

Touch Centralized Controller
MCM-A300N

Air Conditioner user manual



This manual is made with 100% recycled paper.



imagine the possibilities







Thank you for purchasing this Samsung product.

EN ES FR IT PT DE EL NL PL HU RU AR DB68-03944A(2)





Safety precautions

This content is written to protect a user's safety and to prevent property damage. Please read this manual thoroughly and use the product correctly.

 WARNING	Hazards or unsafe practices that may result in severe personal injury or death .
 CAUTION	Hazards or unsafe practices that may result in minor personal injury or property damage .
	Must follow directions.
	Do NOT attempt.
	Make sure the machine is grounded to prevent electric shock.
	Unplug the power plug from the wall socket.
	Do NOT disassemble.

FOR INSTALLATION

WARNING

-  **Plug the power cord into a wall socket with the power specifications of the product or higher and use the socket for this product only. In addition, do not use an extension cord.**
 - ▶ Sharing a wall socket with other products using a power strip or extending the power cord may result in electric shock or fire.
 - ▶ Do not use an electric transformer. It may result in electric shock or fire.
 - ▶ If the voltage/frequency/rated current condition is different, it may cause fire.**Never install the outdoor unit in a location such as on a high external wall where it could fall.**
 - ▶ If the outdoor unit falls, it may result in injury, death or property damage.
-  **Do not install this product near a heater, inflammable material. Do not install this product in a humid, oily or dusty location, in a location exposed to direct sunlight and water (rain drops). Do not install this product in a location where gas may leak.**
 - ▶ This may result in electric shock or fire.**Do not connect the power cable to control terminal.**
 - ▶ Failure to comply may result in electric shock or fire.
-  **This product must be properly grounded. Do not ground the product to a gas pipe, plastic water pipe, or telephone line.**
 - ▶ Failure to do so may result in electric shock, fire, an explosion, or other problems with the product.

FOR INSTALLATION

CAUTION

-  **This product should be positioned in such a way that it is accessible to the power plug.**
 - ▶ Failure to do so may result in electric shock or fire due to electric leakage.**Install the product on a hard and even place that can support its weight.**
 - ▶ If the place cannot support its weight, the product may fall down and get damaged.

FOR POWER SUPPLY**⚠ WARNING**

- ❗ **Remove all foreign substances such as dust or water from the power plug terminals and contact points using a dry cloth on a regular basis.**
 - ▶ Unplug the power plug and clean it with a dry cloth.
 - ▶ Failure to do so may result in electric shock or fire.
- Plug the power plug into the wall socket in the right direction so that the cord runs towards the floor.**
 - ▶ If you plug the power plug into the socket in the opposite direction, the electric wires within the cable may be damaged and this may result in electric shock or fire.
- When the product or power plug or power cord is damaged, contact your nearest service center.**
- ⊘ **Plug the power plug into the wall socket firmly. Do not use a damaged power plug, damaged power cord or loose wall socket.**
 - ▶ This may result in electric shock or fire.
- Do not pull or excessively bend the power cord. Do not twist or tie the power cord. Do not hook the power cord over a metal object, place a heavy object on the power cord, insert the power cord between objects, or push the power cord into the space behind the product.**
 - ▶ This may result in electric shock or fire.
- Do not pull the power cord, when unplugging the power plug.**
 - ▶ Unplug the power plug by holding the plug.
 - ▶ Failure to do so may result in electric shock or fire.

FOR POWER SUPPLY**⚠ CAUTION**

- ❗ **When not using the air conditioner for a long period of time or during a thunder/lightning storm, cut the power at the circuit breaker.**
 - ▶ Failure to do so may result in electric shock or fire.



FOR OPERATION**⚠ WARNING**

- ❗ **If the product is flooded, please contact your nearest service center.**
- If the product generates a strange noise, a burning smell or smoke, unplug the power plug immediately and contact your nearest service center.**
 - ▶ Failure to do so may result in electric shock or fire.
- In the event of a gas leak (such as propane gas, LP gas, etc.), ventilate immediately without touching the power cord. Do not touch the product or power cord.**
 - ▶ Do not use a ventilating fan.
 - ▶ A spark may result in an explosion or fire.
- To reinstall the air conditioner, please contact your nearest service center.**
 - ▶ Failure to do so may result in problems with the product, water leakage, electric shock, or fire.
 - ▶ A delivery service for the product is not provided. If you reinstall the product in another location, additional construction expenses and an installation fee will be charged.
 - ▶ Especially, when you wish to install the product in an unusual location such as in an industrial area or near the seaside where it is exposed to the salt in the air, please contact your nearest service center.

Safety precautions



FOR OPERATION

WARNING

-  **Do not touch the power plug with wet hands.**
 - ▶ This may result in electric shock.**After unpacking the product, keep all packaging materials well out of the reach of children, as packaging materials can be dangerous to children.**
 - ▶ If a child places a bag over its head, it may result in suffocation.
- Do not strike or pull the air conditioner with excessive force.**
 - ▶ This may result in fire, injury, or problems with the product.
-  **Do not attempt to repair, disassemble, or modify the product yourself.**
 - ▶ Do not use any fuse (such as copper, steel wire, etc.) other than the standard fuse.
 - ▶ Failure to do so may result in electric shock, fire, problems with the product, or injury.
-  **If any foreign substance such as water has entered the product, cut the power by unplugging the power plug and turning the circuit breaker off and then contact your nearest service center.**
 - ▶ Failure to do so may result in electric shock or fire.

FOR OPERATION

CAUTION

-  **When an error message is displayed or abnormal operation occurs, stop operation of the product immediately.**
 - ▶ When abnormal operation occurs, turn the product off, disconnect its power supply and contact a service center. If the product is used continuously, electric shock, fire and product malfunction may occur.
-  **Do not stand on top of the product nor place objects (such as laundry, lighted candles, lighted cigarettes, dishes, chemicals, metal objects, etc.) on the product.**
 - ▶ Failure to comply may result in electric shock, fire, product malfunction, or injury.
- Do not operate the product with wet hands.**
 - ▶ This may result in electric shock.
- Do not spray volatile material such as insecticide onto the surface of the product.**
 - ▶ As well as being harmful to humans, it may also result in electric shock, fire or problems with the product.
- Do not press the product with a sharp object.**
 - ▶ Failure to comply may result in electric shock or part damage.

FOR CLEANING

WARNING

-  **Do not clean the product by spraying water directly onto it. Do not use benzene, thinner, alcohol, or acetone to clean the product.**
 - ▶ This may result in discoloration, deformation, damage, electric shock or fire.

Name of each part

Front view



- LCD ON/OFF button**
Turn the screen of LCD on or off.
- Indoor unit operation lamp (Blue)**
Display whether an indoor unit is turned on or off.
- Error lamp (Red)**
Display an error with an indoor unit.



NOTE

- If the color of the LED is red, an error has occurred with a device that the Touch Centralized Controller controls.
- If the color of the LED is blue, a device that the Touch Centralized Controller controls is turned on.

Side view

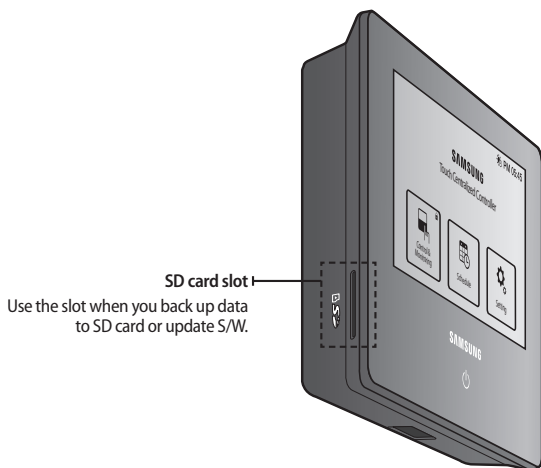

Name of each part

Rear view

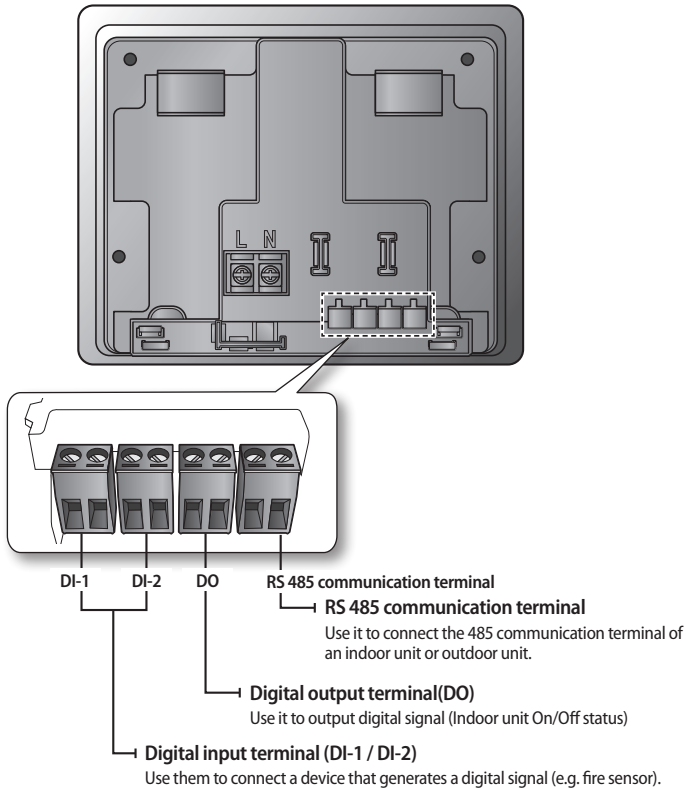

Bottom view

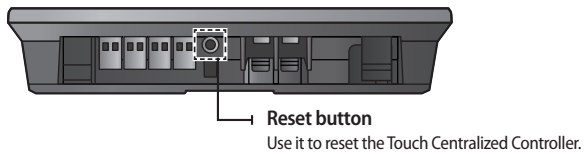

- If there is no input to the Touch Centralized Controller for a while, it will be turned to screen protection mode (LCD backlight is turned off).
- If you press the LCD ON/OFF button in the screen protection mode, the screen protection mode will end.
- Even if the LCD backlight is status 'off', the Touch Centralized Controller is still in operation.

Functions of Touch Centralized Controller

Control and monitoring ()

Touch Centralized Controller can control or monitor the control items of connected indoor units.

Control items	Description	Remarks
Turn All Off	Turn all devices off.	
On/Off	Turn an indoor unit & ERV & DHW on or off.	
Desired temp.	Control an indoor unit & DHW desired temp.	
Fan speed	Control the fan speed.	
Air direction	Control the air direction.	
Mode	Control an indoor unit or ERV operation mode.	
Remote Control	Control the level of a remote controller. (Enable RC / Disable RC / Cond.RC)	
Operation mode limit	Control exclusive mode(Cooling only/Heating only/No limitation).	
Heat upper limit	Limit the maximum desired temperature for heating.	
Cool lower limit	Limit the minimum desired temperature for cooling.	
Additional function	Control motion detection & SPI.	

* ERV: Ventilator, DHW: Control for hot water supply

- ▶ You can select and control one or multiple indoor units.
- ▶ When choosing an indoor unit and selecting the on/off, you can turn on/off the device.
- ▶ After choosing an indoor unit and selecting control, you can control many control items such as desired temp, mode, etc.
- ▶ The control panel displays the status of the last selected device.
- ▶ The special functions such as operation mode limit, cool lower limit or heat upper limit can be controlled by selecting the advanced operation.



CAUTION

- When there is only one zone, it will not be displayed but the devices within the zone will be displayed.
- For detailed information on icons, refer to the legend.

Functions of Touch Centralized Controller

Schedule (📅)

Touch Centralized Controller can control the operation information of an indoor unit with a schedule.

- ▶ You can set a maximum of 10 schedules for a week.
- ▶ One schedule can set a maximum of 10 events.
- ▶ When setting an excluded day, all the set schedules will not work on the corresponding day.

Create schedule

1. Select the **New** button.
2. Items for creating a schedule

Items	Description	Remarks
Name	Enter the name of the schedule.	
Indoor unit 	Select the indoor unit that will be added to schedule control list.	
Schedule	Select the day that the set schedule will work (Sun., Mon., Tue., Wed., Thu., Fri., Sat).	
Event	Set operation of an indoor unit that will be controlled by schedule. <ul style="list-style-type: none"> • Set control time. • Set On/Off. • Set desired temp. • Select operation mode. • Select ERV mode. • Select use of remote controller. 	



Modifying a schedule

Press the schedule you want to modify to move to the modification screen on the 'Schedule' screen. However, you cannot modify the schedule that is in operation and can only check the content.

Deleting a schedule

1. Select the schedule you want to delete. (🗑️)
2. Press the **Delete** button. However, you cannot delete the shedule in operation.

Operating / stopping a schedule

Buttons	Description	Remarks
	Operation status	
	Stop status	

Press the buttons to operate or stop the schedule.

Setting an excluded day

Press the **Excluded day** button on the schedule screen.

1. Adding an excluded day

- 1) Select the day you want to set as an excluded day on the calendar.
- 2) Press the **Add**(➡) button.

Items	Description
<input type="checkbox"/>	Selected day
<input type="checkbox"/>	Added day
<input type="button" value="←"/> <input type="button" value="→"/>	Move monthly
<input type="button" value="⏪"/> <input type="button" value="⏩"/>	Move yearly
SUN	Select or exclude all Sundays in the current calendar.
SAT	Select or exclude all Saturdays in the current calendar.

2. Deleting an excluded day

- 1) Select the excluded day you want to delete. (☑)
- 2) Press the **Delete**(←) button.

3. Saving an excluded day

- 1) When all settings are completed, press the **Save** button.
- 2) Press the (↶) button to cancel the setting.

Functions of Touch Centralized Controller

Setting ()

System settings

1. Lock

- ▶ Screen Lock: You will have to check a password whenever the backlight is turned on with screen lock setting.
- ▶ Operating Panel Lock: You can lock some control items so that other users cannot control the locked items. e.g. A user cannot control the operation mode which you have locked.
- ▶ Menu Lock: A user should be authenticated to use the function of the Touch Centralized Controller with the menu lock setting. When the menu is locked, the () will be displayed.

2. Password

- ▶ Touch Centralized Controller should have the password authentication to operate the functions to which the access of other users is restricted such as tracking, system initialization etc.
 - 1) Set a password for password authentication.
 - 2) The default password is '0000'.

3. Indoor Unit options

- ▶ Auto mode: A user can select the auto mode with auto mode setting. If the use of auto mode is 'Disable', a user cannot select the auto mode.
- ▶ Temperature control step: You can set the unit of temperature control as 1, 0.5, or 0.1. However, if the temperature is displayed as Fahrenheit unit, the temperature control unit will be fixed as 1.
- ▶ Temperature display units: You can set the temperature unit as Celsius or Fahrenheit.

4. Language



- ▶ Touch Centralized Controller supports Dutch, English, French, German, Greek, Hungarian, Italian, Korean, Polish, Portuguese, Slovak, Spanish and Chinese.

5. Time & Date Settings

- ▶ Date/Time: You can set the date and time of the Touch Centralized Controller. You can also set the time as 24 hours display.



• If you enter the date and time incorrectly, the schedule will not work as you want.

- ▶ Select a time-zone: You can set the time-zone of the selected country. The summer time of the selected country will be automatically applied. When the summer time is applied, the icon on the upper screen will be changed from () to ().







6. Screen settings

- ▶ Brightness: You can adjust the brightness of LCD screen of Touch Centralized Controller.
- ▶ Backlight timeout: You can adjust the time for turning the backlight off.

7. Setting & Editing Zone

- ▶ Touch Centralized Controller can conveniently control the installed indoor units by setting a zone or modifying the name of zone and indoor unit.
- ▶ All the devices in the Touch Centralized Controller are included in a group called zone and it is shown by page unit. The page unit is displayed as number such as 1, 2, and 3. Each page has a device. (Zone-Page-Device)
- ▶ The zone can be customized by a user. Create a page in the created zone and move the location of a device.
- ▶ The icon for the zone can also be customized.

Menu of zone list









Icon	Function	Description
	Moving into a Zone	Move inside the zone. The page within the zone and devices within the page will be displayed.
	Creating a zone	Create a zone. You can create a maximum of 12 zones. The created zone will not be deleted arbitrarily unless a user deletes the zone with  (Deleting a zone).
	Deleting a zone	Delete the zone a user has selected. If a device is within the zone, the zone cannot be deleted.
	Changing an icon	You can change an icon of a zone. * For the detailed explanation of the zone icon, refer to legend of control & monitoring.
	Changing a zone name	You can change the name of a zone
	Save	Save the zone that a user has edited and the formation of devices.

- A user can change the order of a zone with drag & drop.

Functions of Touch Centralized Controller

Menu within a zone

You can create a new page with the **N** beside the page number. However, the page without an indoor unit will be automatically deleted with saving.

Icon	Function	Description
	Deleting a page	You can delete the page which does not have devices. <div style="border: 1px solid gray; padding: 5px; margin-top: 5px;">  CAUTION <ul style="list-style-type: none"> You cannot delete the page that has devices. </div>
	Moving a zone	You can move a selected device to another zone
	Moving a page	You can move a selected device to another page.
	Grouping	You can make a group for the selected devices so that a user can view them as one group. When the devices become a group, the last selected device will be the main device and be displayed on the screen.
	Individualizing	You can individualize the devices that have become a group.
	Changing a device name	You can change the name of a device.
	Save	Save the zone that a user has edited and the formation of devices.

- A user can change the order of devices with drag & drop within a page.

 **NOTE** • When there are 2 or more zones, the zone list will be displayed with control & monitoring. When there is one zone, zone list will not be displayed with control & monitoring.

8. Trouble history

▶ You can view the history of the errors with a device.

9. DI pattern

▶ You can define rules that operate according to the DI signal.

Pattern	Description of control
1	<ul style="list-style-type: none"> There is no function.
2	<ul style="list-style-type: none"> When DI-1 ON signal is input, emergency stop status will occur. It will stop all indoor units and order the indoor units not to be controlled by a remote controller. In the emergency stop status, you cannot use the user control command. In addition, the schedule control will not work. When the contact control signal is changed to OFF, the control command can work normally. (DI-2 will not be used with the pattern 2)
3	<ul style="list-style-type: none"> When DI-1 ON signal is input, it will stop all indoor units. When OFF signal is input, all indoor units are ON. When DI-2 ON signal is input, the remote control status of all the indoor units will be enabled and when the OFF signal is input, the remote control status will be disabled.
4	<ul style="list-style-type: none"> It will operate when pulse signal is input to DI-1/2 as contact input. When the pulse contact signal is input to DI-1, ON command will be sent to all indoor units. When the pulse contact signal is input to DI-2, OFF command will be sent to all indoor units.

Installation settings



- The menu of settings on installation is only for a certified installer.

1. Network & Tracking

- ▶ Touch Centralized Controller explores installation information and status information of the devices which form the system for 10 minutes. To use this function, you need user authentication.
- ▶ In addition, you can select Show / Hide() for the device that has completed the tracking. You can also hide the device which is found during the tracking with the Hide function.



- When performing the tracking for the first time, all devices will be included in one zone.
- The zone information edited by a user will be maintained even if you perform the tracking.

2. Data backup & restoration

- ▶ Save all user information of a Touch Centralized Controller to a SD card and restore the information from this data.
- ▶ For the data restoration, you need user authentication.



- When using the function of the data backup or data restoration, you need to insert the SD card to the Touch Centralized Controller.

3. Device settings

- ▶ You can allow the control of a On/Off controller with a remote controller from Touch Centralized Controller and can change the communication address of the Touch Centralized Controller.

4. System Initialization

- ▶ You can delete all user information of Touch Centralized Controller. To use this function, you need user authentication.

Device Information

1. Version information: The version information of the Touch Centralized Controller is displayed.
2. For the information of open source, refer to [Setting]-[Device Information].

Trouble shooting

Before reporting on the product malfunction, please check the table below.

Problem	Check	Solution
Screen of LCD does not show anything.	Is power supplied correctly?	After checking the power supply connection, plug in the product again.
	Is the product in screen protection mode?	When there is no input by a user for a certain time, the LCD will be turned off automatically. Turn the LCD screen on with LCD ON/OFF button.
Indoor unit control does not work.	Is the communication cable unplugged?	Check the connection status of communication cable between an indoor unit and outdoor unit.
Desired temperature does not increase or decrease.	Has 'Heat upper limit' or 'Cool lower limit' been set?	When the temperature limit is set, a user can adjust the desired temperature within the range of the temperature limit.
Remote controller does not work.	Is the use of the remote controller restricted?	If the Remote control level is set as Disable RC, you cannot control the indoor unit with wireless or wired remote controller.
Schedule control does not work with the set time.	Is the set time of product different from current time?	Set the current time again at the menu of [Setting]-[System Settings]-[Time & Date Settings].
Modifying a schedule is not available.	Is the schedule in operation?	Modification of a schedule is available only in stop status.

Product specifications

Model	MCM-A300N
Display	7 inch-capacitive touch(800*480)
Operating system	Linux 2.6.35.3
CPU	IMx53
Memory	RAM : 512MB, ROM:1024MB
Expansion slot	SD Card
Interface	Reset button, Touch button
Communication terminal	RS485, Digital Input, Digital output
Using type	Wall-mounted type
Power supply	100~240 V (50/60 Hz)

- ▶ Design and product specification may be changed without notice in advance for improvement of product quality.
- ▶ If installation is performed with agencies not certified by Samsung Electronics Co., Ltd., free service will not be available.
- ▶ Use rated cables for electric work and the additional work such as extension of electric wire or installation of auxiliary power switch will be charged to a customer.

Product dimension

